

Datasheet

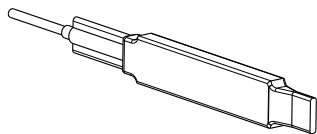

- Suitable for below ground installation
- Encapsulated circuit board housing sealed with adhesive-lined heat shrink
- Capable of detecting vehicles that have stopped within the sensor's sensing field
- 3-axis magnetoresistive-based technology; senses 3-dimensional changes to the Earth's magnetic field caused by the presence of ferrous objects
- Easy sensor installation
- Compact, robust one-piece, self-contained sensor package replaces inductive-loop sensing technology; no external controller needed
- Designed to minimize the effects of temperature swings and destabilizing magnetic fields
- Sensor learns ambient background and stores settings sensor will not lose configuration or range when power is cycled



WARNING:

- **Appropriate use for vehicle detection**—The mechanical opening, braking, and reversing systems of the door will not respond in sufficient time to prevent moving trucks, cars, or material handling vehicles, even those traveling at low speeds, from coming in contact with the door. In addition, the detection zone of the device may fluctuate due to changes in the local magnetic environment.
- Failure to follow these procedures may result in serious injury or death.
- All vehicles should approach doors at speeds that allow the operator to ensure the door is operating properly and in an open position.



WARNING:

- **Do not use this device for personnel protection**
- Using this device for personnel protection could result in serious injury or death.
- This device does not include the self-checking redundant circuitry necessary to allow its use in personnel safety applications. A device failure or malfunction can cause either an energized (on) or de-energized (off) output condition.

Models

Model ¹	Cable	Cable Type	Supply Voltage	Output Type ²	Range
Q7LMEB W/6	1.83 m (6 ft) cable	26 gage/5-wire shielded cable with 4 mm (0.160 in) diameter polyurethane jacket	10 to 30 V DC	Bipolar NPN/PNP	Range varies depending on application and target being sensed. See Typical Target Excess Gain Curves on p. 7.
Q7LMEB W/15	4.57 m (15 ft) cable				
Q7LMEB W/30	9.14 m (30 ft) cable				
Q7LMEB W/50	15.2 m (50 ft) cable				
Q7LMEB W/100	30.5 m (100 ft) cable				
Q7LMEB W/200	61 m (200 ft) cable				
Q7LMEBQ5	150 mm (5.9 in) cable with a 5-pin M12 quick disconnect				

¹ A model with a QD connector requires a mating cable; see [Cordsets](#) on p. 8. QD cables are not suitable for buried applications.

² Contact Banner Engineering for other output options.



Overview

The Q7LMEB sensor implements a passive sensing technology to detect large ferrous objects. The sensor measures the change in the Earth's natural magnetic field (the ambient magnetic field) caused by the introduction of a ferromagnetic object.

The Q7LMEB sensor provides a direct replacement for inductive loop systems and needs no external frequency box. Its unique design allows quick installation within a single 3/8 in saw cut. For applications where pavement has not been poured, consider the M-GAGE S18M, which can be mounted or replaced without disrupting the pavement.

For best performance, mount the sensor below-grade, in the center of the traffic lane. The Q7LMEB may be mounted above-ground.

Theory of Operation

The sensor uses three mutually perpendicular magnetoresistive transducers. Each transducer detects magnetic field changes along one axis. By incorporating three sensing elements, maximum sensor sensitivity is achieved.

A ferrous object will alter the local (ambient) magnetic field surrounding the object. The magnitude of this magnetic field change is dependent both on the object (size, shape, orientation, and composition) and on the ambient magnetic field (strength and orientation).

During a simple programming procedure, the Q7LMEB measures the ambient magnetic field. When a large ferrous object (for example, a truck, automobile, or rail car) alters that magnetic field, the sensor detects the magnetic field changes (anomalies). When the degree of magnetic field change reaches the sensor's threshold, the sensor's discrete outputs switch.

Sensor Field of View and Range

The sensor range depends on three variables:

1. The local magnetic environment (including nearby ferrous material)
2. The magnetic properties of the object to be sensed
3. Sensor settings

The Q7LMEB can detect changes in the ambient magnetic field in all directions. As with other sensors, the range will depend on the target. The strong disturbance of a large ferrous object decreases as the distance from the sensor increases, and the magnitude and shape of the disturbance is dependent on the object's shape and content.

The sensor can be programmed to react to magnetic field disturbances of greater or lesser intensity using two adjustments: background condition and sensitivity level.

Once background condition and sensitivity level are set, the sensor is ready to detect the target object. Both settings are stored in non-volatile memory.

Figure 1. Baseline Magnetic Field

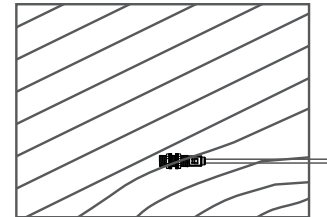

A. Baseline magnetic field, with slight disturbances caused by permanent ferrous-metal objects within or near the sensor.

Figure 2. Introduction of Large Steel Object

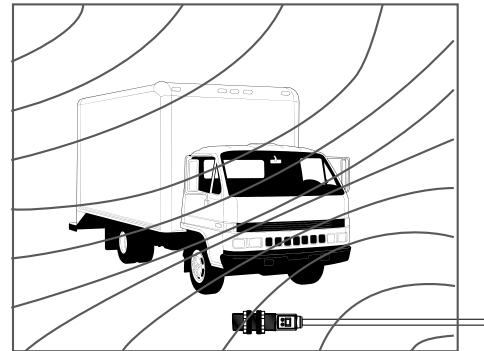

B. After a large steel target object is introduced, the sensor detects the differential (magnetic strength and orientation) between fields A and B. If the differential is greater than the sensitivity threshold, the sensor's outputs conduct.



Tip: Sensor may be mounted inside a non-ferrous architectural detail for cosmetic or security reasons. It is important that, wherever it is mounted, the sensor is securely attached during configuration and all later use. If the sensor moves after being taught, detection errors may occur and sensor must be re-taught. If a sensor appears to lose its taught settings, it may be a result of having shifted position after setup.

Configuration Instructions

Sensor Configuration

The sensor is configured via its gray Remote wire. The gray wire is always active and the sensor may be re-configured at any time. **For optimum performance, secure the sensor so that it will not move either during or following the configuration.**

Programming pulses may be executed by connecting the sensor's gray wire to the sensor's blue (common) wire with a normally open mechanical button connected between them, or as a low (< 2 V DC) signal from a programmable logic controller (PLC), or using the model DPB1 Portable Programming Box as shown. When a PLC is used for configuration, the pulses are acknowledged via the sensor output signal.

When the DPB1 is used, the pulses are accomplished by clicking the DPB1 **TEACH** push button (0.04 seconds ≤ click ≤ 0.8 seconds). The sensor's output status is reflected by the DPB1 Output indicator LED.

Figure 3. Connecting to the model DPB1 Portable Programming Box

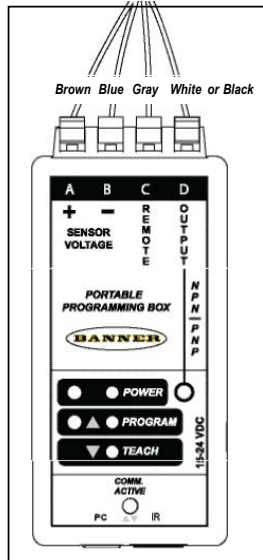

Push the **TEACH** button to pulse the remote wire.

Configuration



Set Background Condition (No Vehicle Present)

Wire the M-GAGE™ sensor as directed. Remove all vehicles and all other metal objects that are temporarily in the sensing area before setting the background condition.

Configuration ($0.04 \leq T \leq 0.8$ seconds)		Result
Set Background Single-pulse the remote wire. 	Sensor learns background. Outputs toggle approximately 12 times while the background is taught. Sensor returns to Run mode.	

Set Sensitivity Level

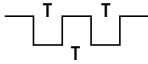
Level 1 = least sensitive, Level 6 = most sensitive.

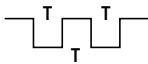
Configuration ($0.04 \leq T \leq 0.8$ seconds)		Result
Access Sensitivity Mode Double-pulse the remote wire. 	Output toggles 1 to 6 times every 2 seconds to indicate the current sensitivity level (for example, two flashes indicates level 2). When DPB1 is used, the sensor always begins at sensitivity level 1.	
Adjust Sensitivity To increase the sensitivity incrementally, single-pulse the remote wire again; continue until the desired sensitivity level is reached. 	Output toggles from 1 to 6 times every 2 seconds to indicate the sensor's sensitivity level (for example, two flashes indicates level 2).	
Double-pulse the remote wire to save the setting. 	Sensor returns to Run mode.	

Configuration (0.04 ≤ T ≤ 0.8 seconds)		Result
Test Operation	Drive a vehicle past the sensor to trip the output. Use a small/light vehicle to ensure larger vehicles will be detected later.	Verify Output comes On as expected.
	Adjust the sensitivity as needed.	
Prepare for Operation	Disconnect DPB1 or other temporary switch used for configuration and connect the sensor to a permanent power supply/ output device (user-supplied). See Wiring on p. 4.	

Wiring

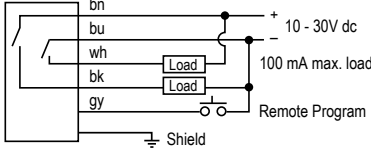
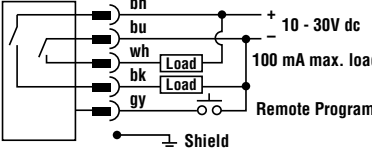
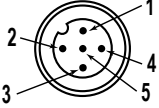
Cabled Model	Quick-Disconnect Model	Pinout
		 <p>1 = Brown 2 = White 3 = Blue 4 = Black 5 = Gray</p>

Installation Instructions

Below-Grade Installation

Optimally, the Q7LMEB should be mounted in the center of the vehicle traffic lane (see [Figure 6](#) on p. 5). The axles of the vehicles provide the most effective and most repeatable magnetic field changes. When replacing an inductive loop, the geometric center of the failed loop is typically a good location for mounting.

For applications at the side of the traffic lane, consider the movement of metallic objects within a few feet of the sensor on the side opposite the traffic lane, even if the activity is not visible, for example behind a wall, or inside a building. Consult a Banner Applications Engineer with any questions.

The Q7LMEB sensor's narrow housing allows the sensor to be mounted in pavement, within a single 3/8-in. saw cut. Typically, saw cut depths of 2 inches to 4 inches are sufficient. Consult Banner Engineering Applications if you are planning to install the sensor more than 24 inches below the final grade. The sensor cable will fit into a slot as narrow as 1/4 inches. If a blade smaller than 3/8 in. is used, make a double cut to account for the sensor width. Rebar or other metal embedded in the pavement will not affect the sensor's performance.

Figure 4. Sensor placed in saw cut in pavement

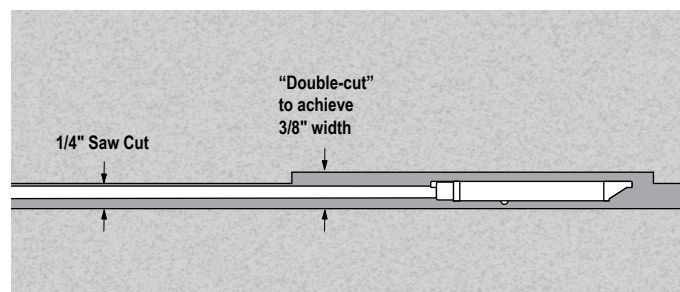

CAUTION: Check for any utility pipes or wires, including heated floors, when cutting into pavement or floors.

Use an air hose to remove loose particles and moisture from the saw cut. Lay the sensor and cable into the saw cut, with the cable extending back to the control cabinet. Fill the saw cut with loop or pavement sealer. **Do not fill the saw cut with heated asphalt.** Work the sealant around the sensor and cable with a thin object to eliminate any trapped air gaps.

Above-Grade Installation

The Q7LMEB is non-directional, and can be mounted in any position. The sensor may be mounted on a non-ferrous architectural detail for cosmetic or security reasons.

Select a location as close as possible to the vehicle(s) to be detected.

In applications where the sensor is mounted to the side of the vehicle traffic lane (for example, in a kiosk, menu board, or gate control box), consideration must be made for movement of metallic objects within a few feet of the sensor on the opposite side of the traffic lane, even if the activity is not visible (for example, behind a wall or inside a building). Consult Banner Applications Engineer for further information.

When mounting a QD-cable model, it is recommended to route the cable through conduit for protection from environmental conditions.

Verify the sensor is securely attached during configuration and operation. If the sensor moves after being taught, detection errors may occur and the sensor must be re-taught. If a sensor appears to lose its taught settings, the sensor may have shifted position after configuration.

Figure 5. Above-Grade Installation

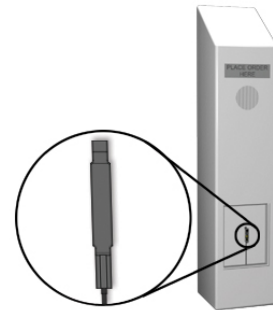

Installation Placement Considerations

Figure 6. Example good sensor placement

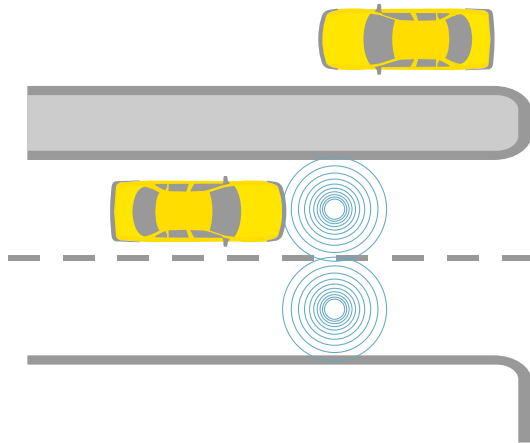
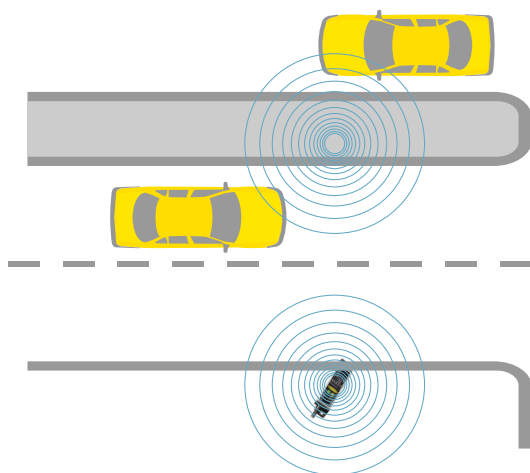

Figure 7. Example bad sensor placement



Good Placement

Figure 6 on p. 5 shows the optimum placement of M-GAGE sensors for vehicle detection. When the sensor is positioned in the middle of the traffic lane, it can be configured to a lower sensitivity level and still detect vehicles in the lane of interest only. This is known as lane separation, or not detecting a vehicle in an adjacent lane.

A lower sensitivity level also aids the sensor in vehicle separation – detecting a break between the back bumper of a leading vehicle and the front bumper of the next vehicle. With proper placement and configuration, the M-GAGE can achieve vehicle separation with distances of 635 mm (24 in) or less between vehicles.

Bad Placement

Figure 7 on p. 5 depicts a potential problem installation. While mounting the sensor at the side of a lane may be successful, this mounting location increases the potential for detection problems. To reliably detect a vehicle from the side, the sensor sensitivity must be increased in order to see objects further away in the lane of interest. Unfortunately, this enables the sensor to also detect another object operating behind the sensor or vehicles in adjacent lanes, which will cause false counts.

Place the M-GAGE sensor at the edge of a traffic lane only if there is no possibility of other objects being detected by the sensor. A good practice is to ensure that no vehicles will be within 3.05 m (10 ft) of the sensor on the non-traffic side.

Other Considerations

For sub-surface installations that do not utilize non ferrous, environmentally secure enclosures, the use of loop sealant to provide environmental isolation to the sensor is required. Care should be taken to fully encapsulate the sensor in environmentally stable sealant as part of the installation process. Please contact Banner Engineering for more information.

Specifications

Supply Voltage

10 V DC to 30 V DC (10% maximum ripple) at 43 mA, exclusive of load
Above +50° C (+122° F), supply voltage is 10 V DC to 24 V DC (10% maximum ripple)

Axis Sensitivity

1.5 counts/milligauss (typical)

Sensing Technology

Passive three-axis magnetoresistive transducer

Supply Protection Circuitry

Protected against reverse polarity and transient voltages

Output Configuration

Two SPST solid-state outputs conduct when object is sensed; Bipolar NPN/PNP

Output Protection

Protected against short-circuit conditions

Output Ratings

100 mA maximum (each output)
NPN saturation: 0.4 V at 10 mA and <2.0 V at 100 mA
NPN OFF-state leakage current: < 200 microamps
PNP saturation: < 1.4 V at 10 mA and < 2.5 V at 100 mA
PNP OFF-state leakage current: < 5 microamps

Output Response Time

20 milliseconds

Delay at Power-Up

0.5 seconds

Drift Filter

Enabled
Time: 4 hours

Connections

Shielded 5-conductor (with drain) polyethylene jacketed attached cable or 5-pin Euro-style QD PVC pigtail (see [Cordsets](#) on p. 8)

Sensor Function Control:

Expanded control of XYZ axis

Patent

U.S. Patent 6,546,344 B1

Operating Conditions

-40 °C to +70 °C (-40 °F to +158 °F)
100% maximum relative humidity

Vibration and Mechanical Shock

All models meet Mil. Std. 202F requirements method 201A (vibration: 10 to 60 Hz maximum, double amplitude 0.06 inch, maximum acceleration 10G). Also meets IEC 947-5-2: 30G 11 ms duration, half sine wave.

Environmental Rating

Leak proof design is rated IEC IP69K; NEMA 6P

Remote TEACH Input

Impedance 12K ohms (low \leq 2 V DC)

Adjustments

Configuration of Background Condition and Sensitivity Level may be set by pulsing the gray wire remotely via the portable programming box

Construction

Housing: E-coated aluminum
End Caps: Thermoplastic polyester
Circuit board encapsulated with 2-part polyurethane. Housing sealed with adhesive-lined polyolefin heat shrink.

Certifications



Required Overcurrent Protection



WARNING: Electrical connections must be made by qualified personnel in accordance with local and national electrical codes and regulations.

Overcurrent protection is required to be provided by end product application per the supplied table. Overcurrent protection may be provided with external fusing or via Current Limiting, Class 2 Power Supply. Supply wiring leads < 24 AWG shall not be spliced. For additional product support, go to www.bannerengineering.com.

Supply Wiring (AWG)	Required Overcurrent Protection (Amps)
20	5.0
22	3.0
24	2.0
26	1.0
28	0.8
30	0.5

Dimensions

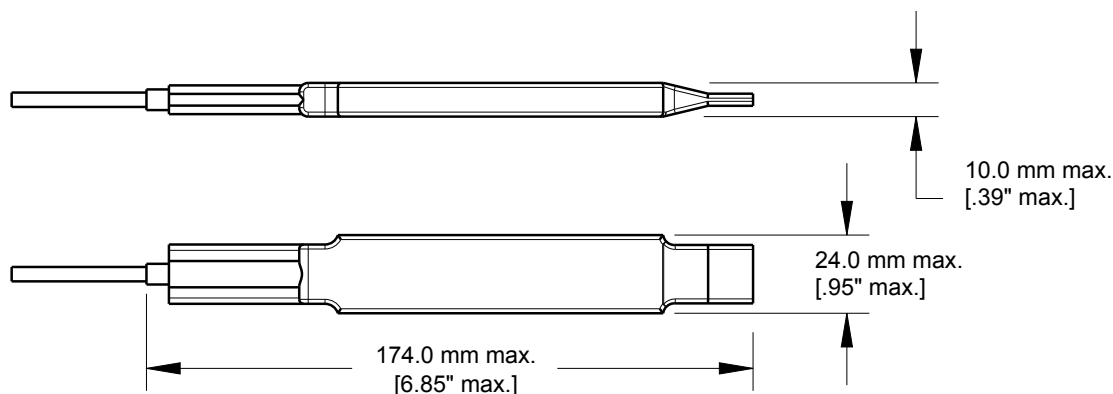

Typical Target Excess Gain Curves

After the sensor has been securely mounted and configured, it is ready to operate. The following example application shows typical responses for the M-GAGE™ sensor.

Figure 8 on p. 7 describes mounting the M-GAGE™ 1 meter (3.3 ft) above the ground to sense an automobile. The graph shows the excess gain for a typical car. Excess gain is a measure of the amount of extra signal detected by the sensor over and above the Level needed to detect the target. This example assumes a Level 5 sensitivity threshold.

The table at right compares the change in excess gain if the sensitivity Level changes. If the sensitivity is at Level 6, then the excess gain at a given distance would be 1.3 times larger than for a Level 5 sensitivity. Conversely, if the sensitivity threshold is Level 1, then the excess gain would be one third as big as for Level 5.

Table 1: Excess Gain vs Sensitivity Level (Assumes Level 5)

Level	Excess Gain Multiplier
1	0.33
2	0.4
3	0.5
4	0.66
5	1.0 (default)
6	1.3

Figure 8. Application example: sensor mounted 1 meter (3.3 ft) above ground

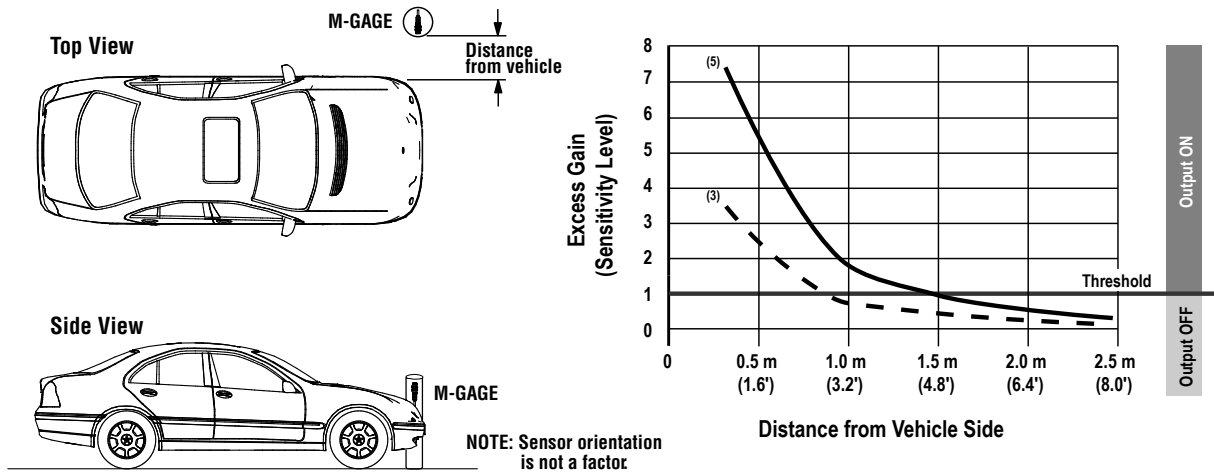

Figure 9. Application example 2: sensor mounted 0.25 meters (0.8 ft) below ground

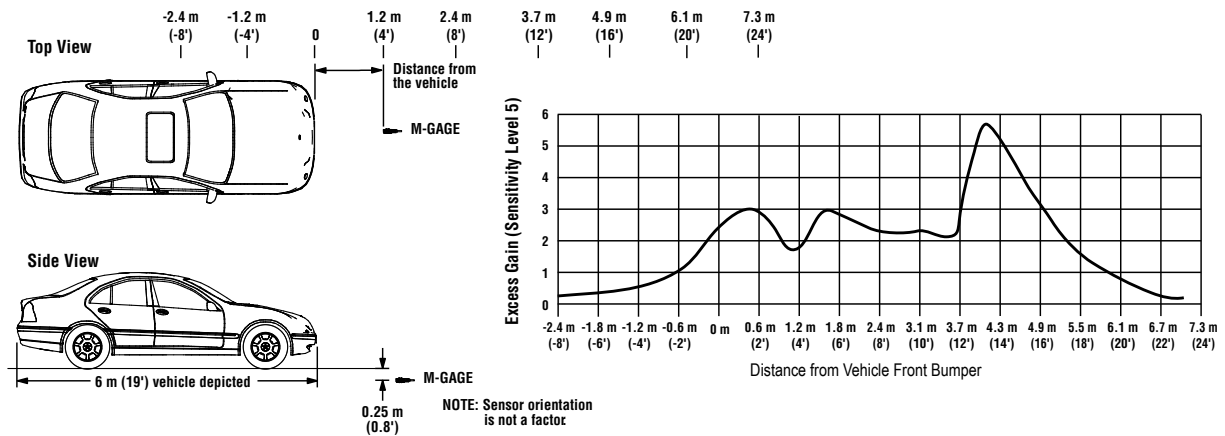

Figure 9 on p. 7 illustrates a typical vehicle passing over a sensor mounted underground. Note that excess gain is greatest when the bulk of the vehicle (the rear axle) is positioned directly over the sensor.

Accessories

Model	Description
DPB1	Handheld Portable Programming Box, used for configuring sensor when push button is not accessible